

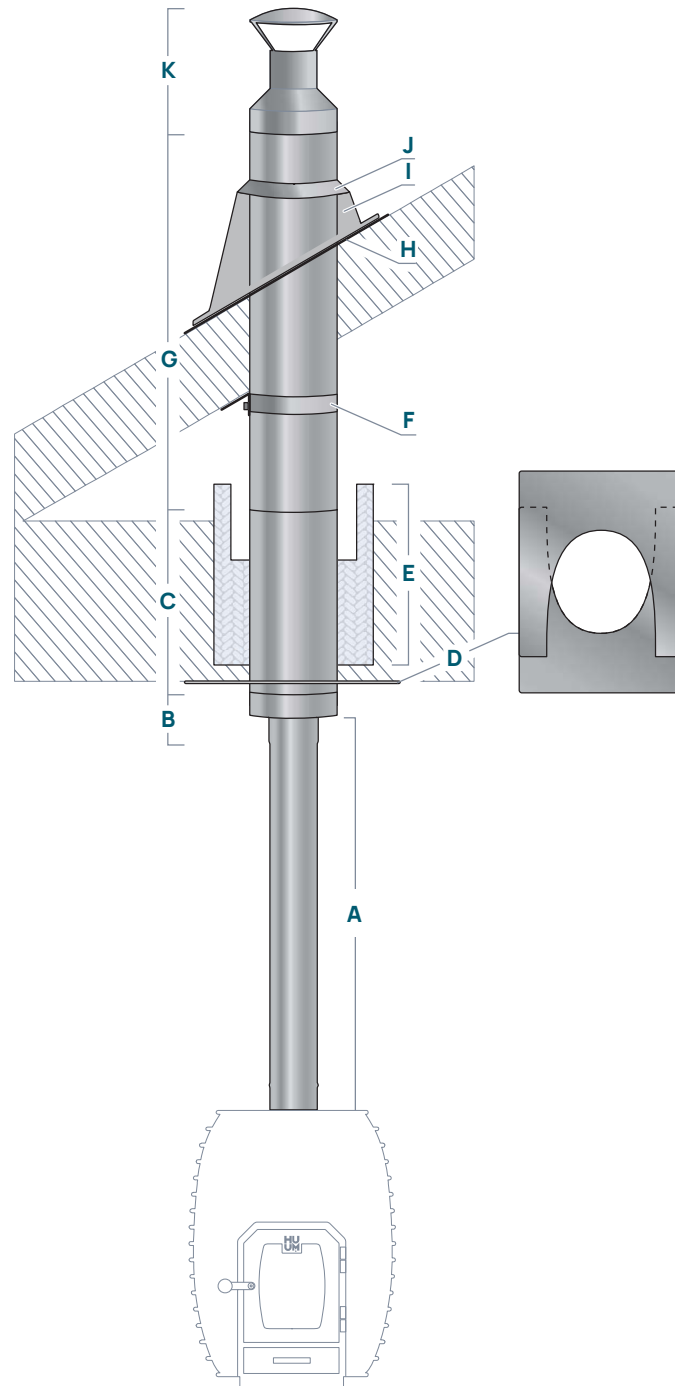









♥ OF SAUNA



CHIMNEY SET THROUGH THE CEILING

- | | | | |
|---|---|---|---|
|  A | Single-wall pipe 1 m |  G | Double-wall straight pipe 1 m |
|  B | Chimney base, welded |  H | Roof underlay seal Ø 160-230 (optional) |
|  C | Double-wall chimney 0.5 m |  I | Ventilated roof flashing 20-35 degrees |
|  D | Cover plate for inclining ceiling (2 parts) |  J | Rain collar |
|  E | Partition ceiling insulation with cooling T600 (optional) |  K | Chimney cap |
|  F | Roof rafter attachment to the chimney | | |