

# INSTALLATION MANUAL

200x200 "Sauna Emma Glass"

## 1. Preparations

- Sauna package must be stored in a heated and dry room.
- Prior to installation the package must be opened and stored for 48h to adjust to relative humidity of the room (22°C, 40-60% RH).
- Ensure the sauna model fits in the designated room with sufficient extra room for ease of installation.
- Clean the location of sauna with care in order to not damage any details, elements
- Room must be well ventilated and with water drain on or near the position of the sauna.
- Sauna is intended to be installed on a level surface to ensure proper installation and quality of the installed product.
- Adequate electrical supply must be ensured for electrical components of the sauna. Refer to user manuals of respective products.
- Electrical connections to the power grid and to the sauna may only be carried out by legally competent and certified specialist.
- Producer cannot be held responsible for any errors resulting from disregard to the levelness of substructure, inadequate storing conditions, inadequate power supply, unauthorized alterations to components or any other circumstances occurring from deviations described in this manual and/or good customs.

## 2. List of tools

- Water level
- Tape measure
- Power drill
- Rubber or plastic mallet
- Silicone gun
- Screwdriver set

Installation of a sauna requires at least two (2) persons.

## 3. Installations

- Follow the instructions precisely.
- Always start from 1 and continuously move forward in an organized manner.
- Keep the installation site always clean and organized.
- This manual does not take into account any possible peculiarities of the installation site.
- Take care not to damage any components during installation due to dropping, dragging or careless handling.
- Special attention towards elements - they must be stored with care and kept away from any hard or sharp objects. Glasses are tempered and even smallest damages to the surface or corners can lead to concentration of stress and shattering of the glass.

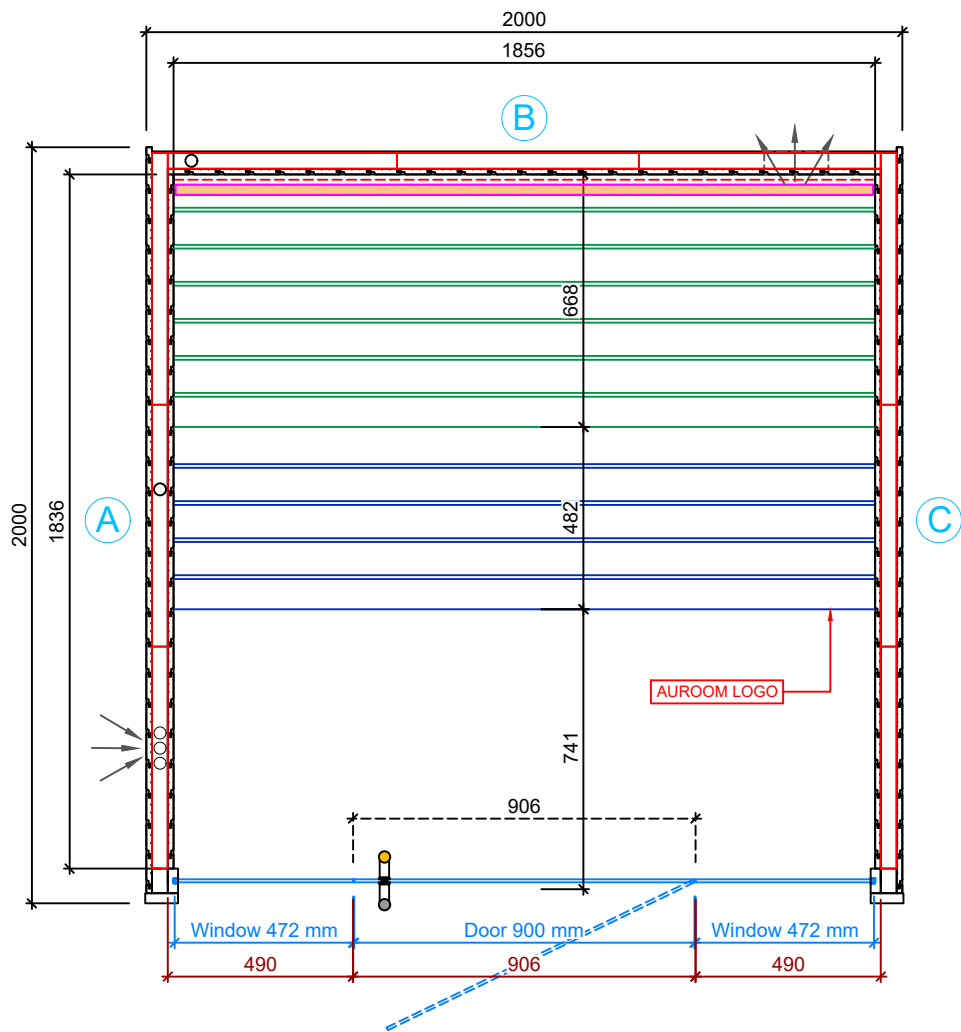

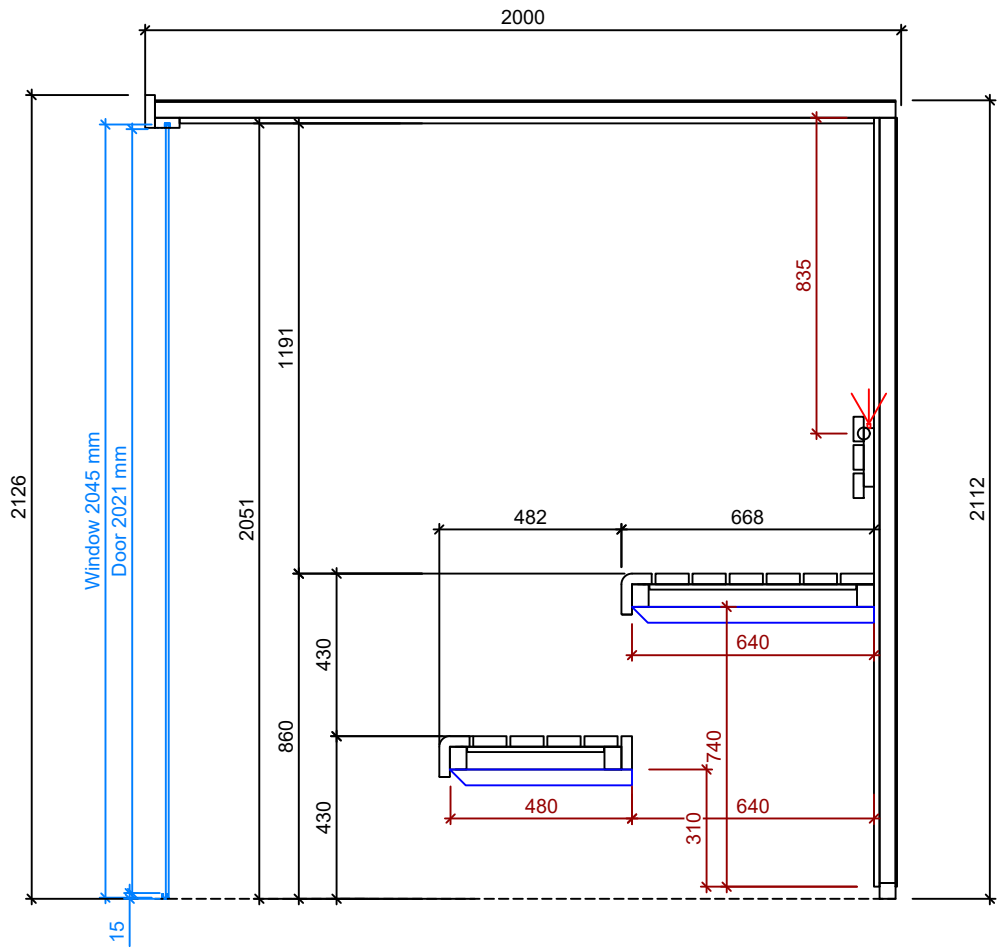

LEGEND	
	WALL LABELLING
	VENTILATION AIR INLET 90x170 mm NEAR THE FLOOR
	VENTILATION OUTLET 90x170 mm IN THE WALL UNDER THE UPPER BENCH
	BACKREST
	UPPER BENCH
	LOWER BENCH

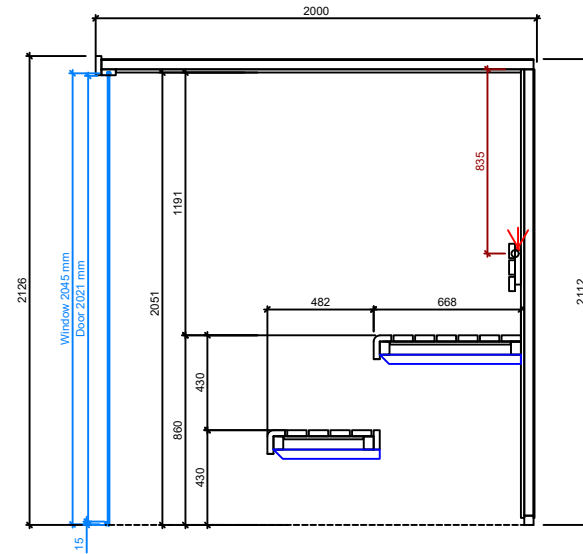
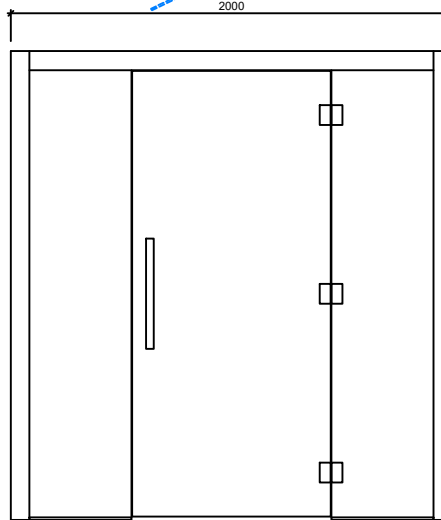
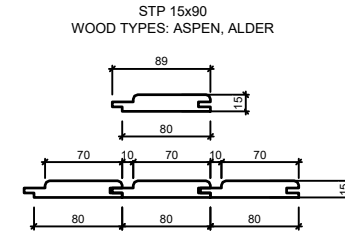
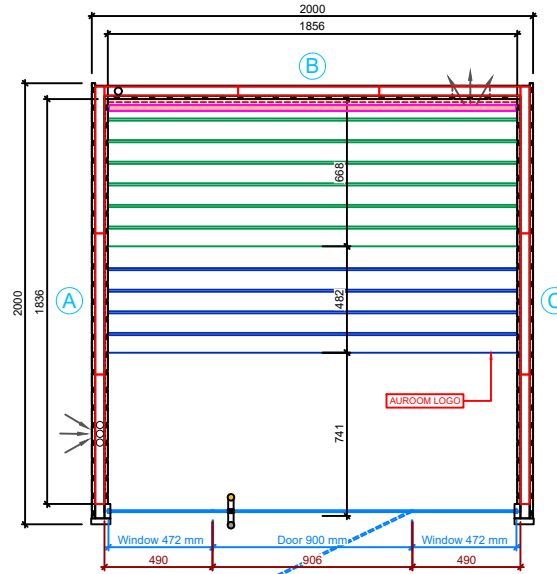

## BASE FRAME

1. Check substructure level. Sauna must be installed on a level surface.
2. Connect the base frame elements
3. Fix the elements with screws
4. Check baseframe diagonals for equality and right corners
5. Apply silicone under baseframe and fix in place

NOTE! If the sauna is to be moved after installation, silicone can be installed afterwards.

Figure a.

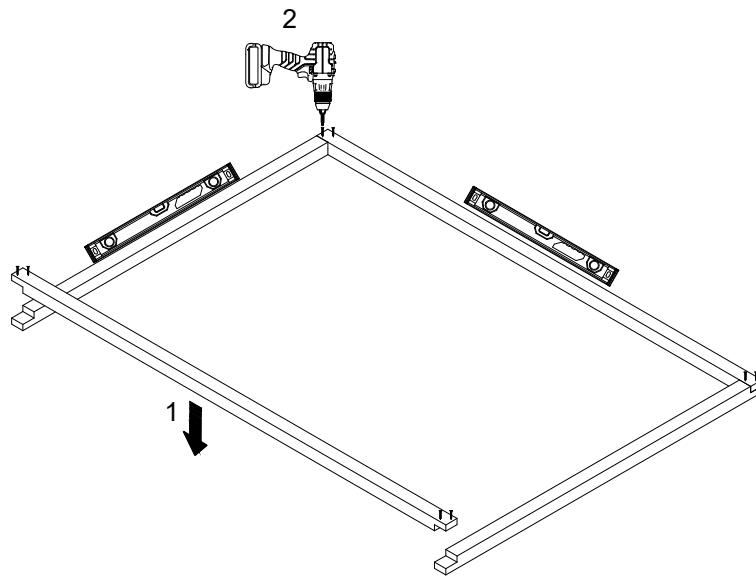
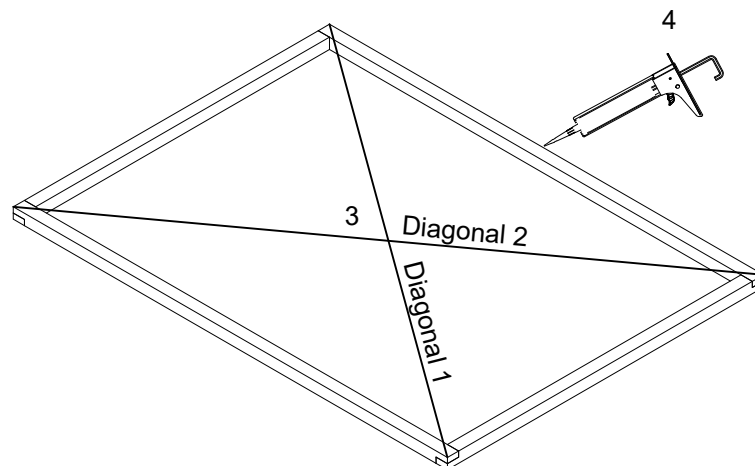
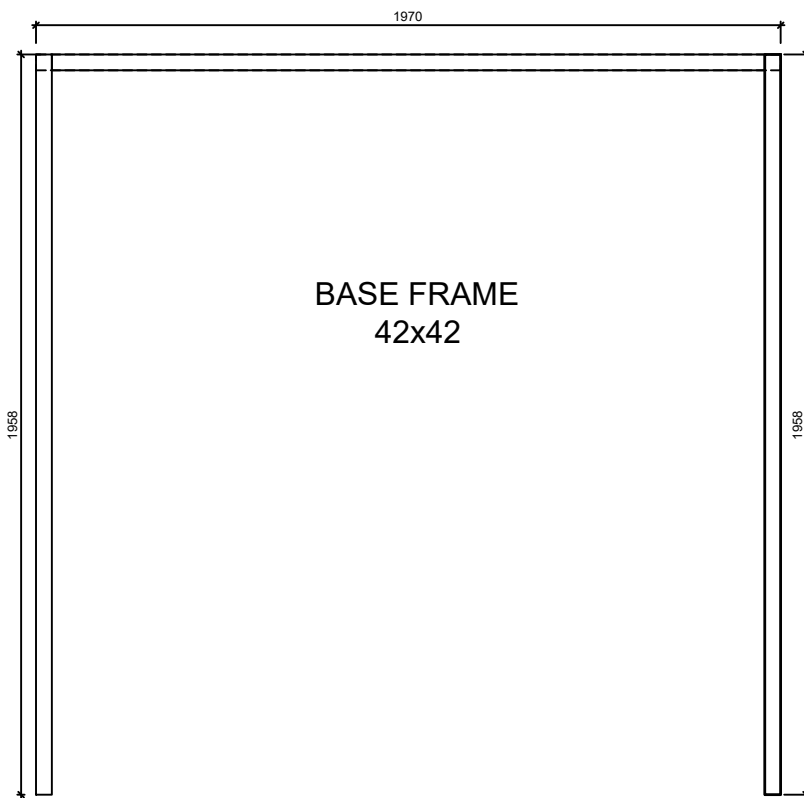

Figure b.



# BASE FRAME



# VERTICAL WALL ELEMENTS

- 1. See your technical drawing on next page
- 2. Separate walls by letters
- 3. Control wall symbols on base frame

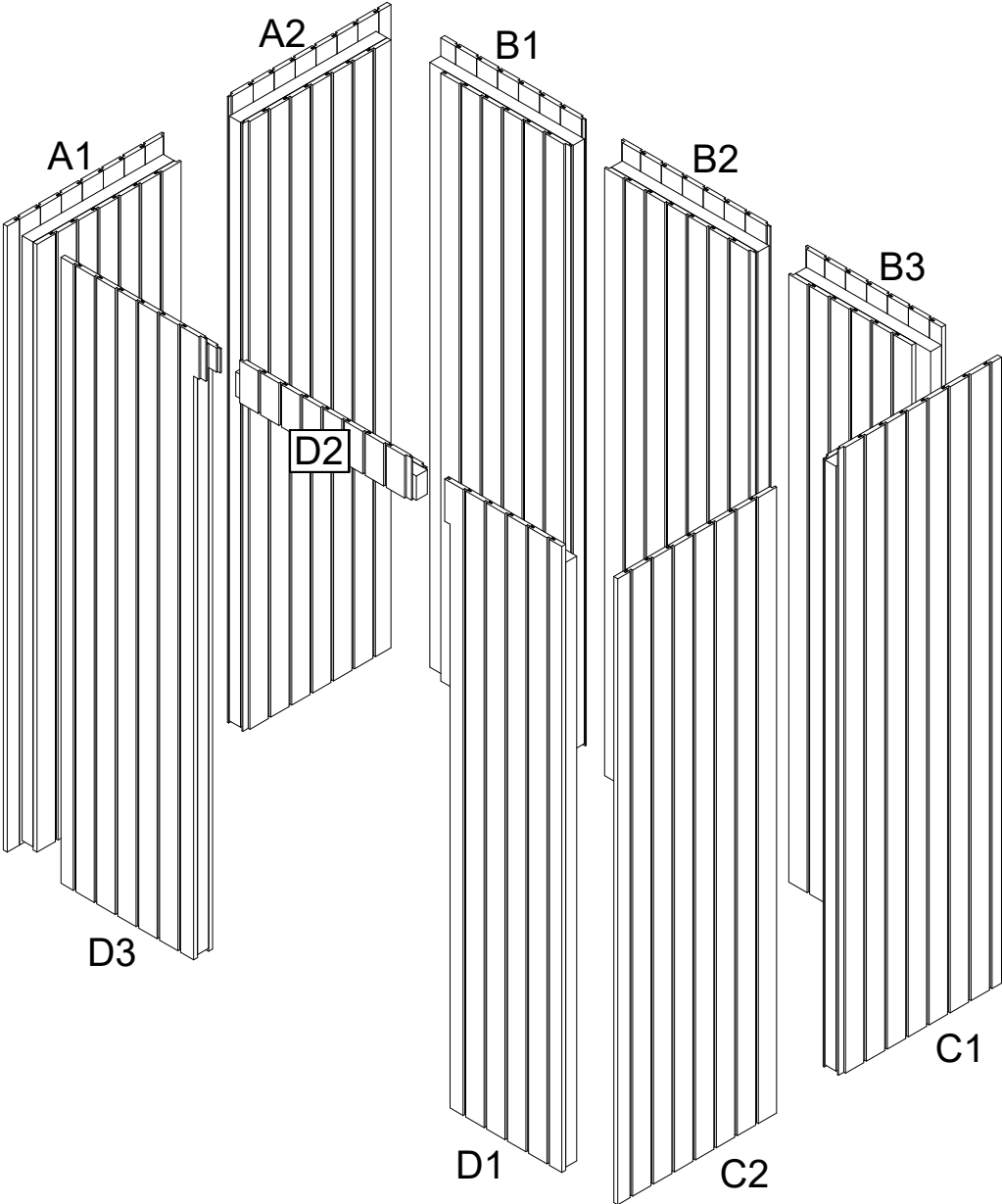

\*Example picture



# VERTICAL WALL ELEMENTS

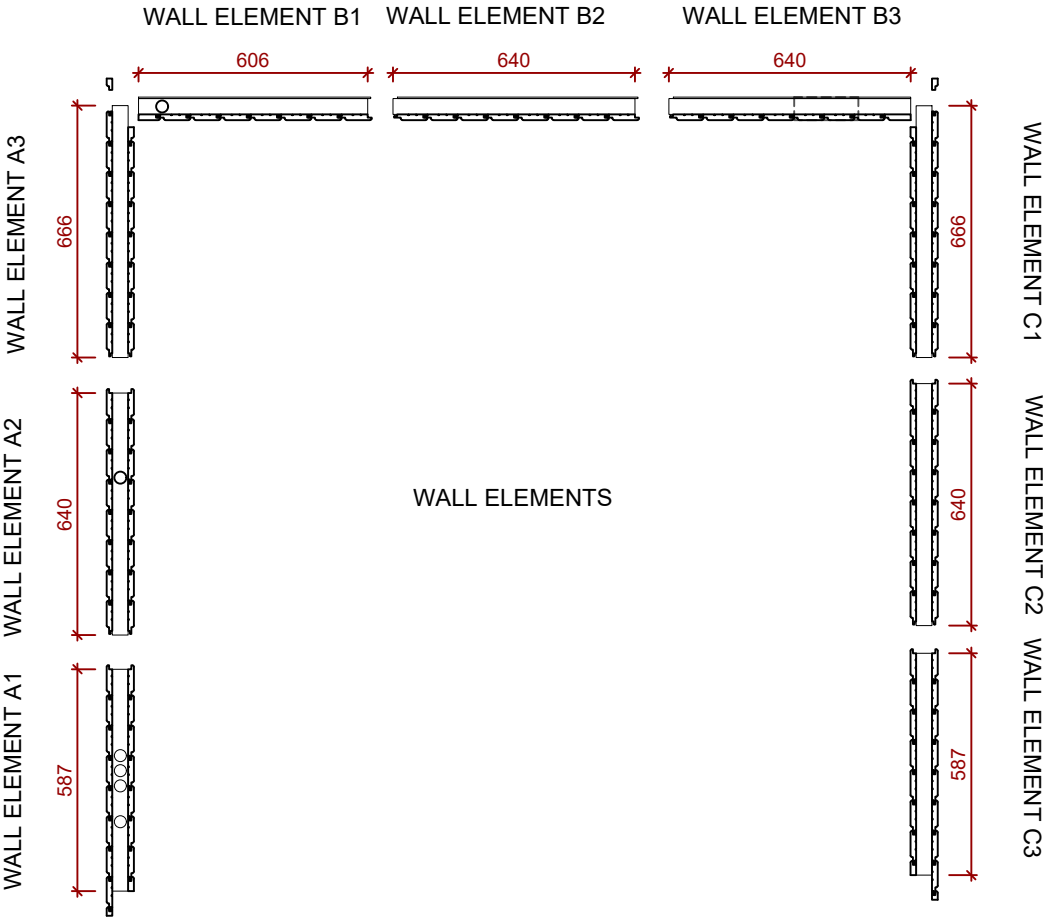

# VERTICAL WALL FIXING

1. Start fixing walls from A-B corner
2. Place walls on base frame
3. Fasten screws from top
4. Fix corners outside

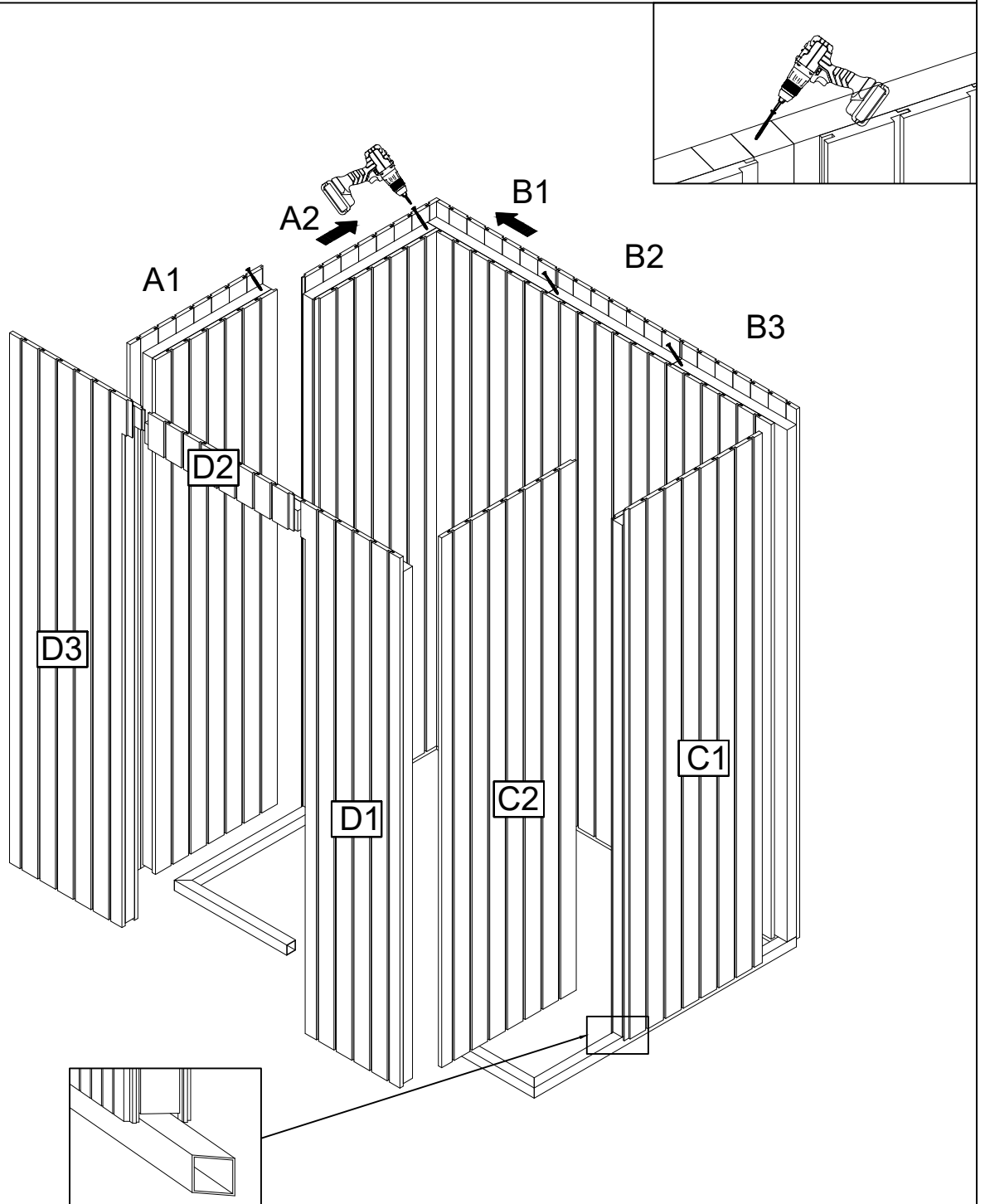

\*Example picture

## CEILING ELEMENTS FIXING

1. See your technical drawing on next page
2. Start fixing from ceiling element 1
3. Pay attention to inside paneling
4. Fix screws from top
5. Use plywood blocks against paneling bend

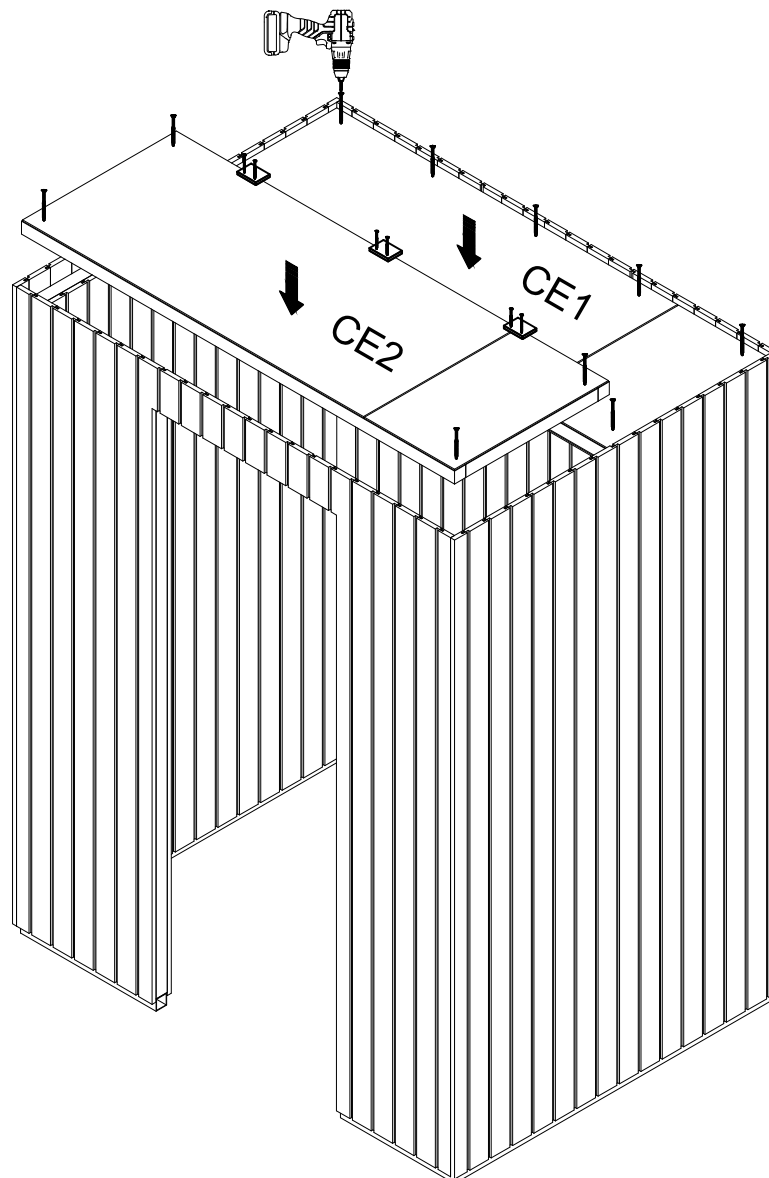

\*Example picture

# CEILING ELEMENTS

## CEILING ELEMENTS

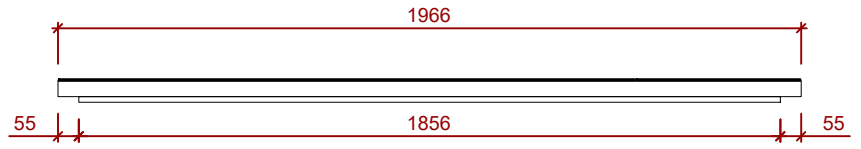

CEILING ELEMENT 1

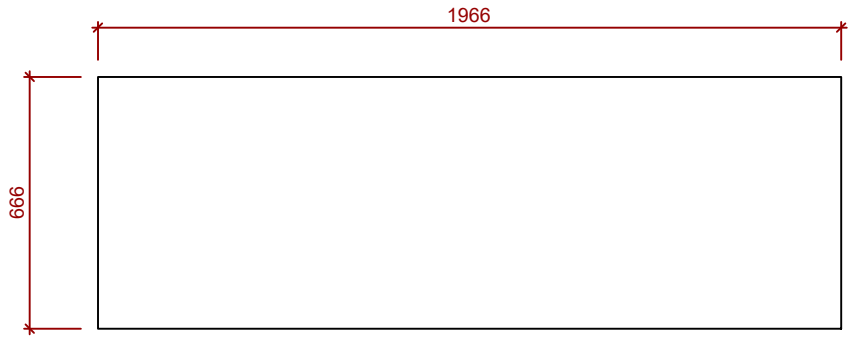
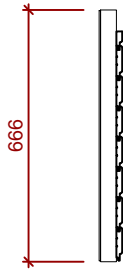

CEILING ELEMENT 2

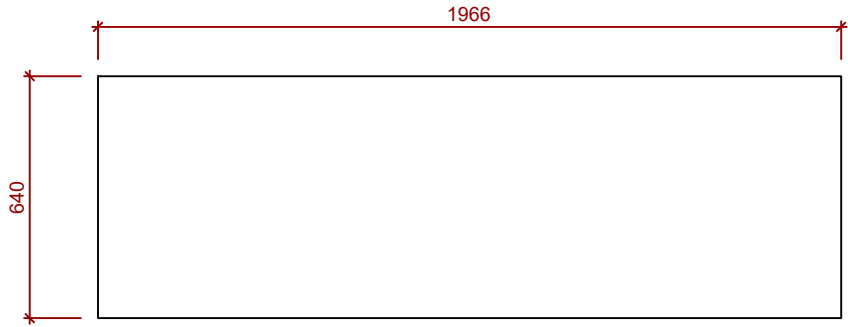
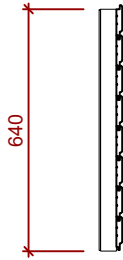

CEILING ELEMENT 3

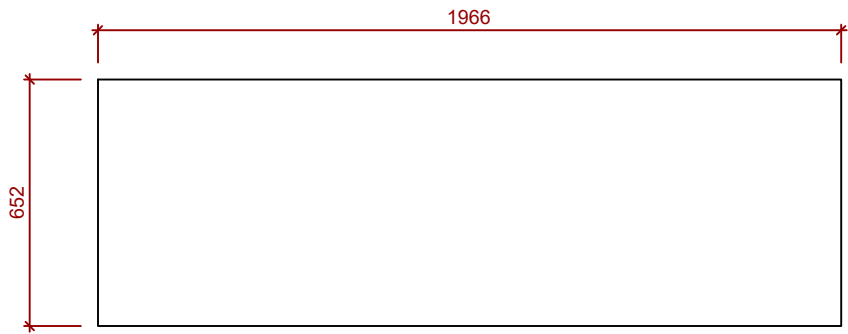
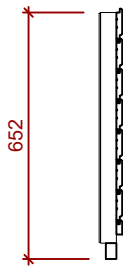

## HORIZONTAL BENCH SUPPORTS

1. See your technical drawing on next page
2. Measure right placement of supports
3. Check level
4. Fix screws

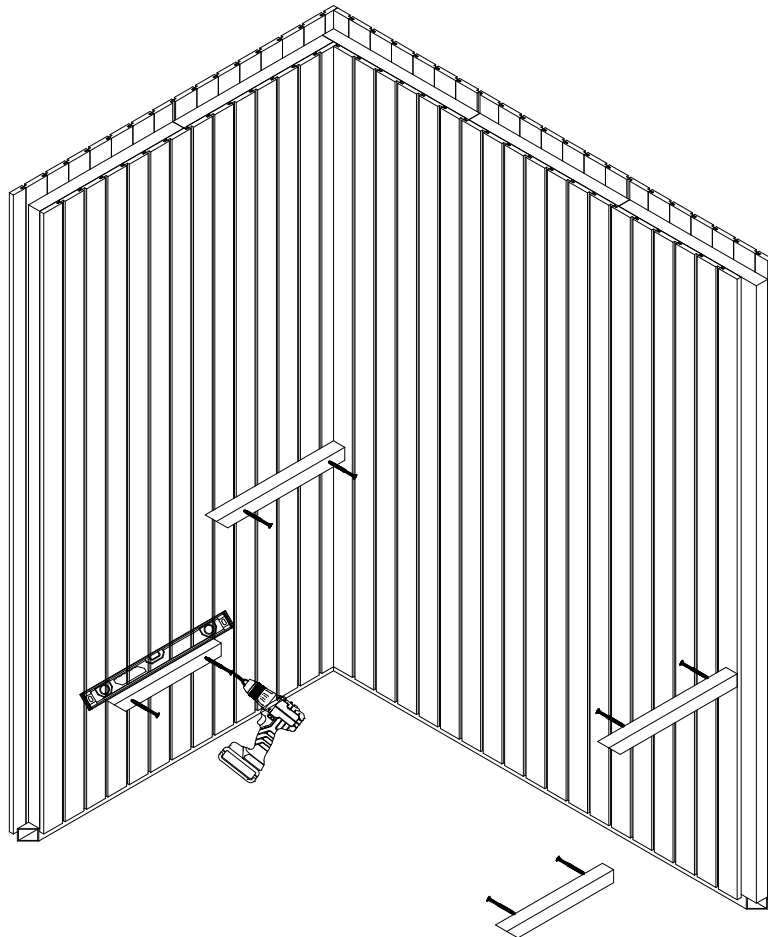

\*Example picture



## FIXING BENCH FRAMES

1. Place bench frames on supports
2. Control measures from cross-section drawing
3. Level benches
4. Fix side screws to tighten walls
5. Fix back screws

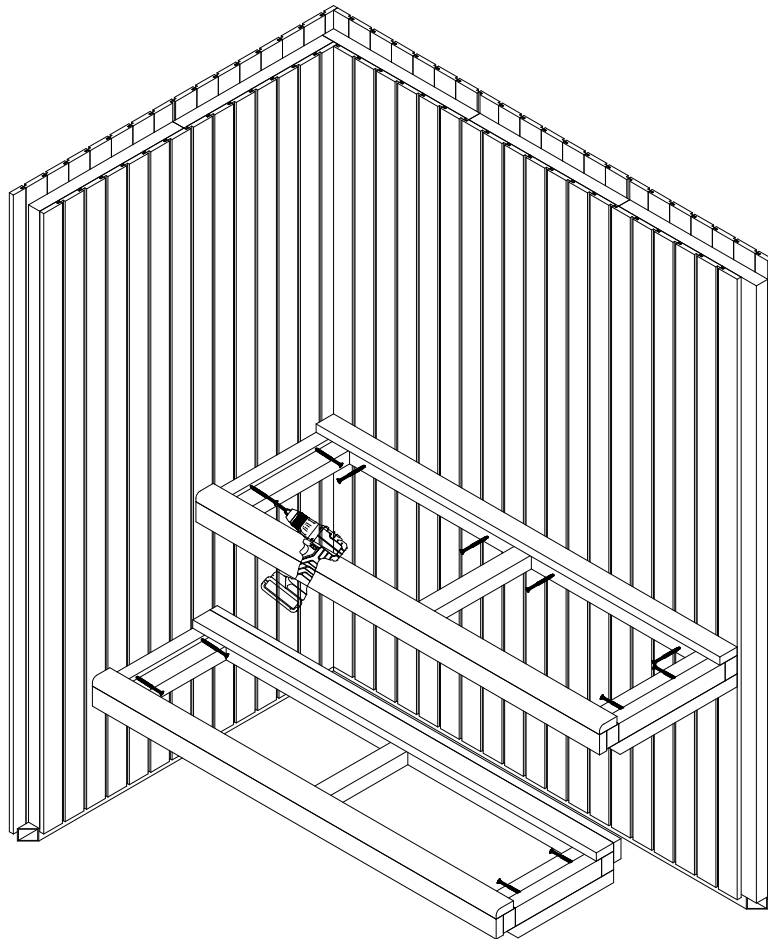

\*Example picture

## FIXING BENCH GRIDS

1. Place bench grids on bench frames
2. Fix bench grids from below with screws
  - \*Fixing bench grids helps to prevent bench grid from bending

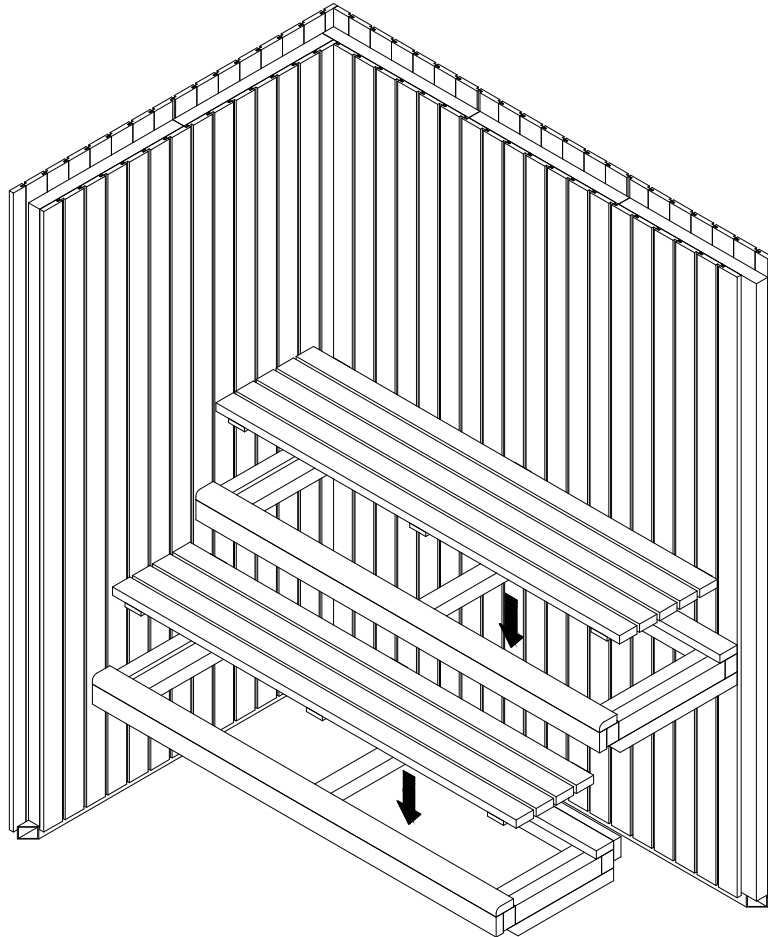

\*View from bottom

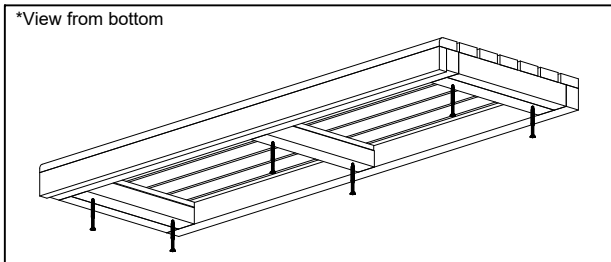

\*Example picture



## FIXING BACKREST WITH HOLDERS

1. Fix holders on the wall
2. Place backrest on top of holders
3. Fix backrest to holders from top
4. Use wooden covers

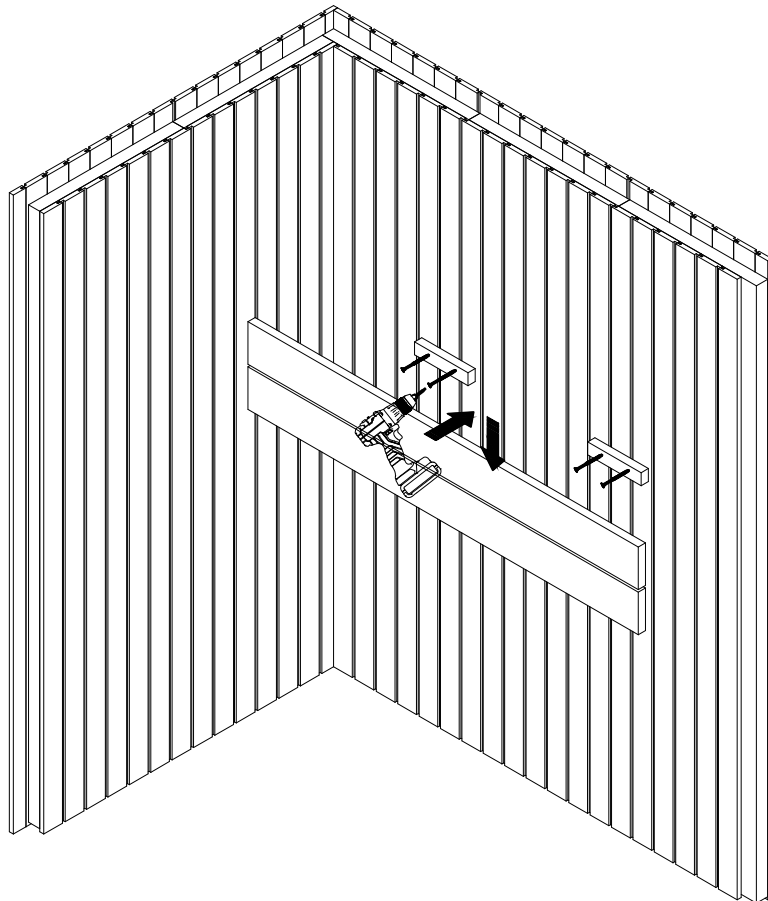

\*Example picture

# ELECTRICAL

1. Run cables through pre drilled holes in the walls to the ceiling

NOTE! ALL ELECTRICAL CONNECTIONS **MUST** BE MADE BY CERTIFIED ELECTRICIAN!

## ELECTRICAL DIAGRAM

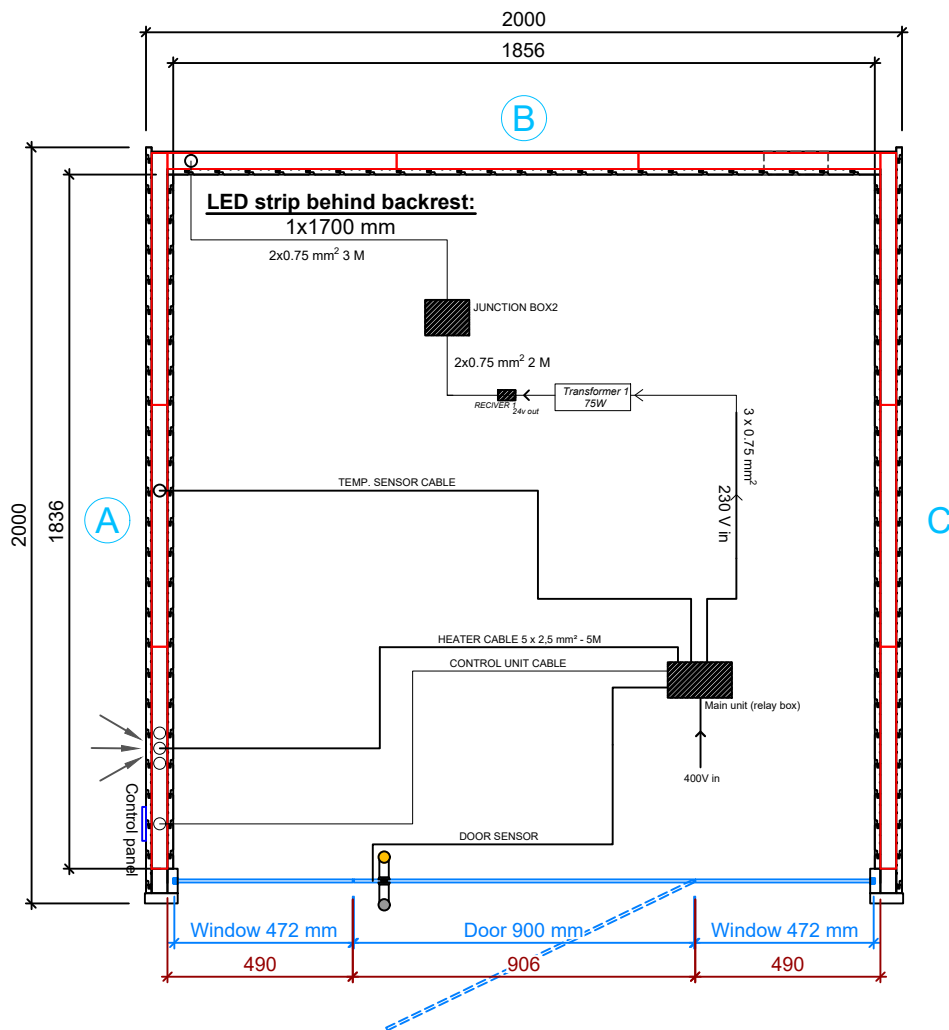

# FIXING GLASS WALL

## GLASSWALL 1

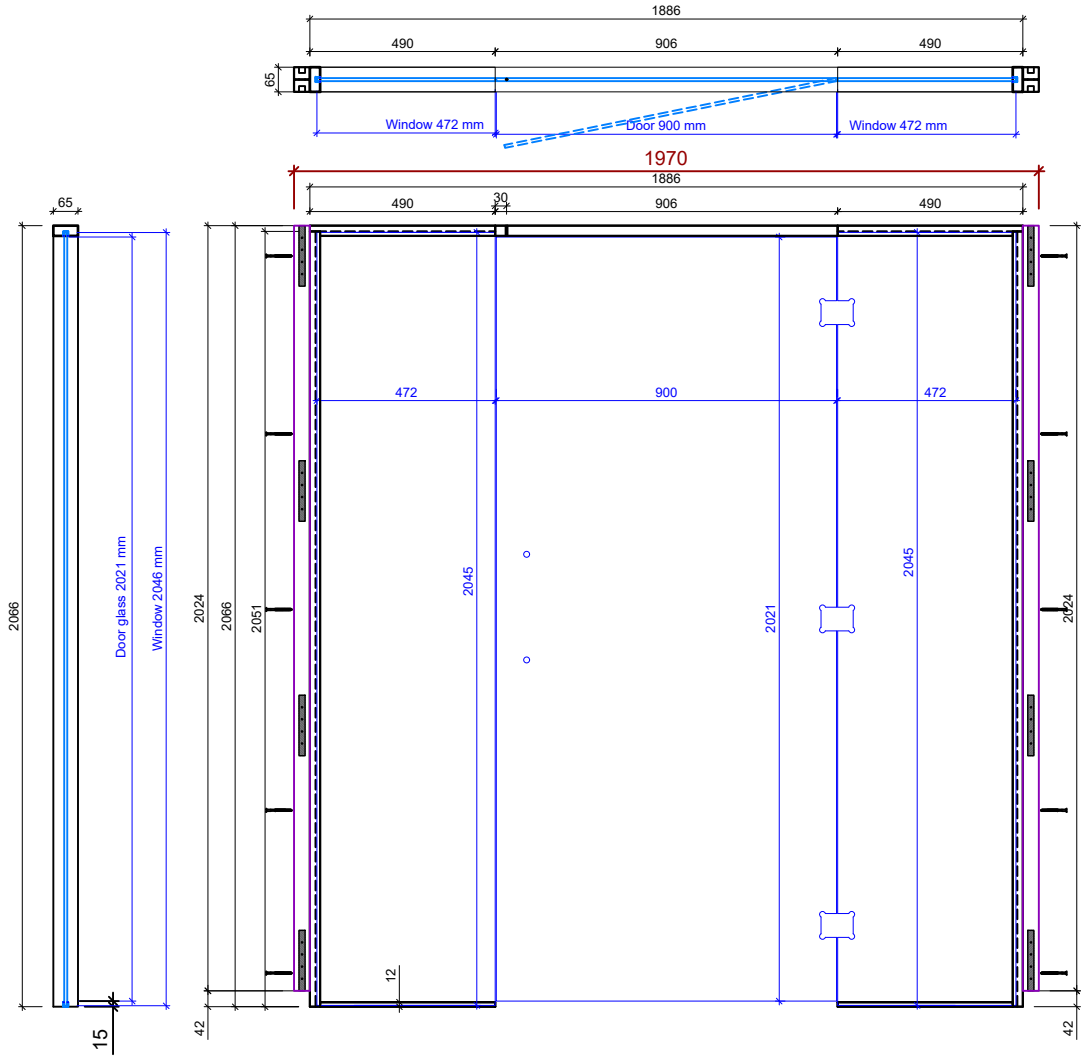

## FIXING GLASS WALL

1. See your technical drawing on next page
2. Fix window frames
3. Fix door frame detail
4. Use wooden covers

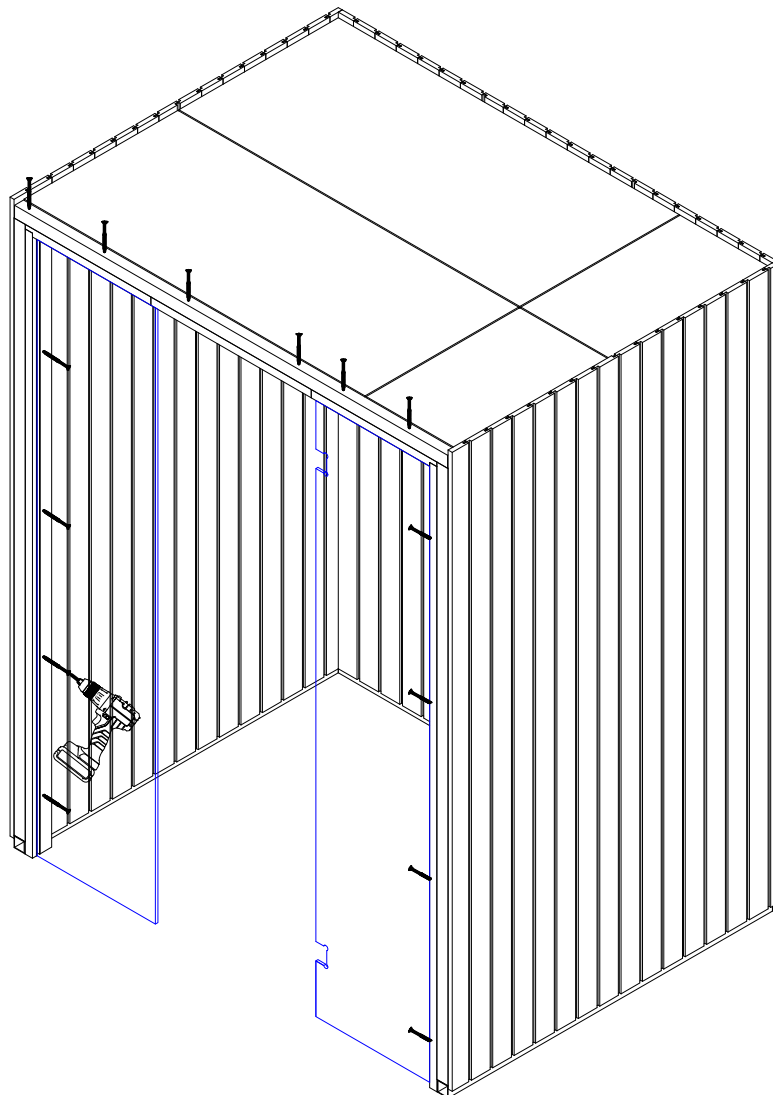

\*Example picture

# DOOR GLASS

1. Fit the hinges on door according to Figure C.
2. Fit the door to glass wall according to Figure C.
3. Fit the handle to the door according to Figure B.

**NOTE!** Door must not be supported directly to a hard (tiled, concrete or other) floor due to risk of shattering. Always when not installed rest the door on a protected floor. Do not remove protection material from door until it is finally and properly fitted.

Figure A.

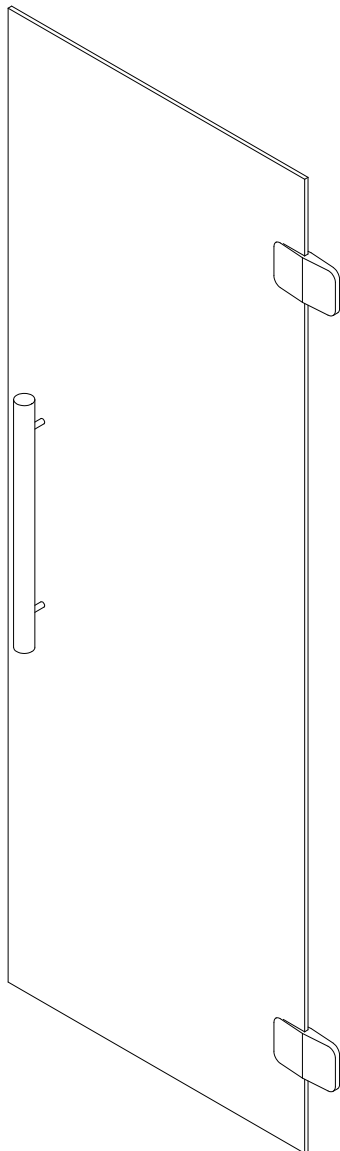

Figure B.

Premium handle

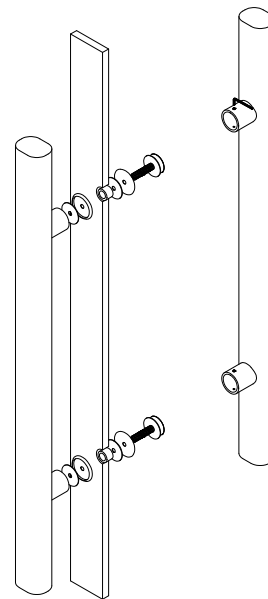
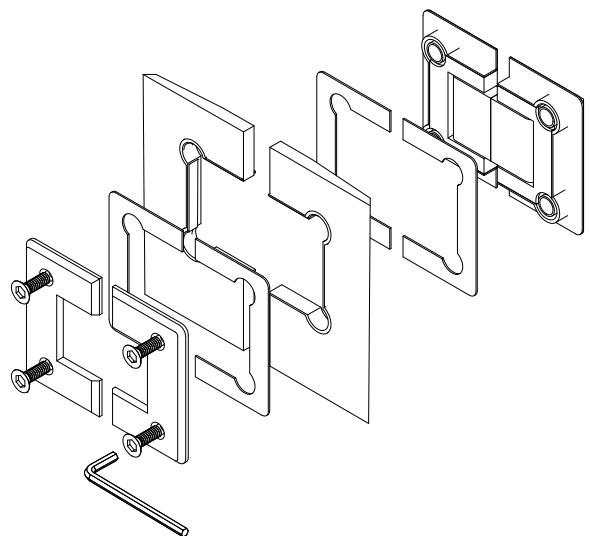

Figure C.

Glass-glass hinges



## FIXING FRONT FRAME

1. See your technical drawing on next page
2. Fix vertical frames with multiclips
3. Fix horizontal frame with screws from top

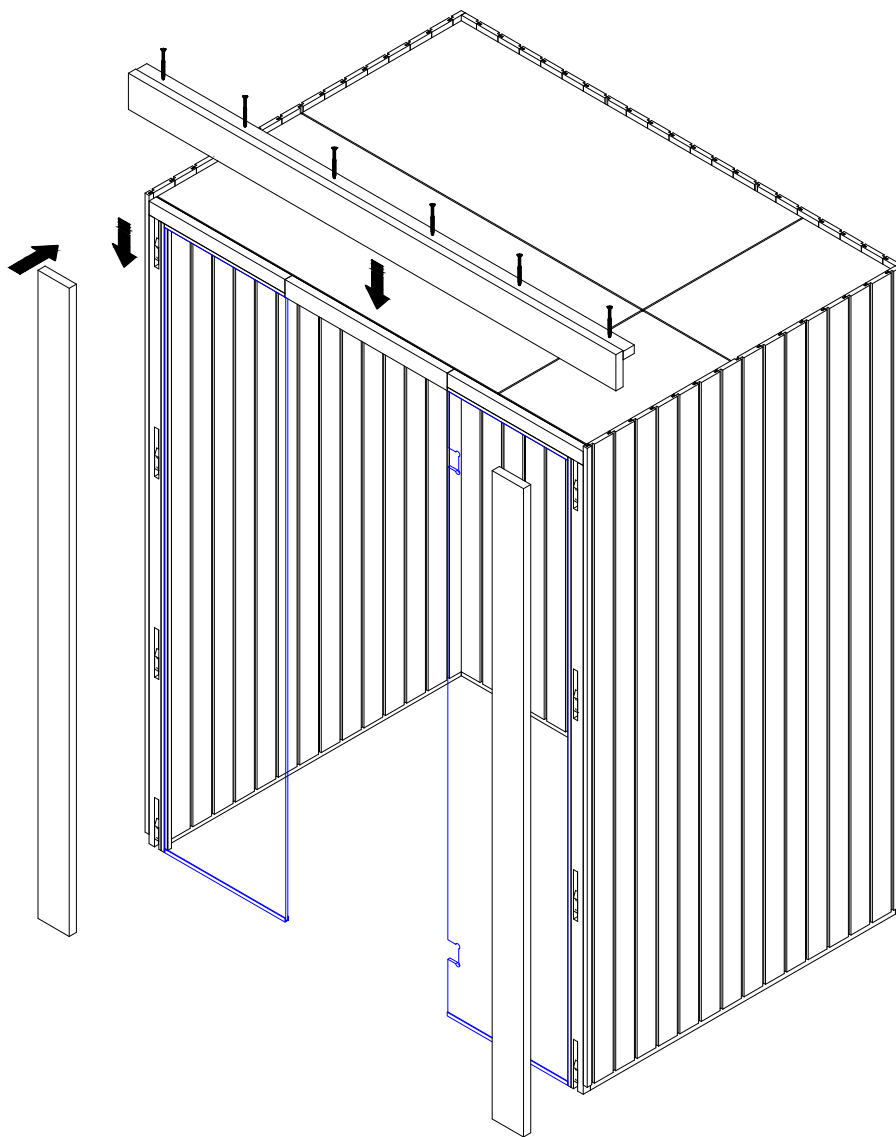

\*Example picture

# FIXING FRONT FRAME

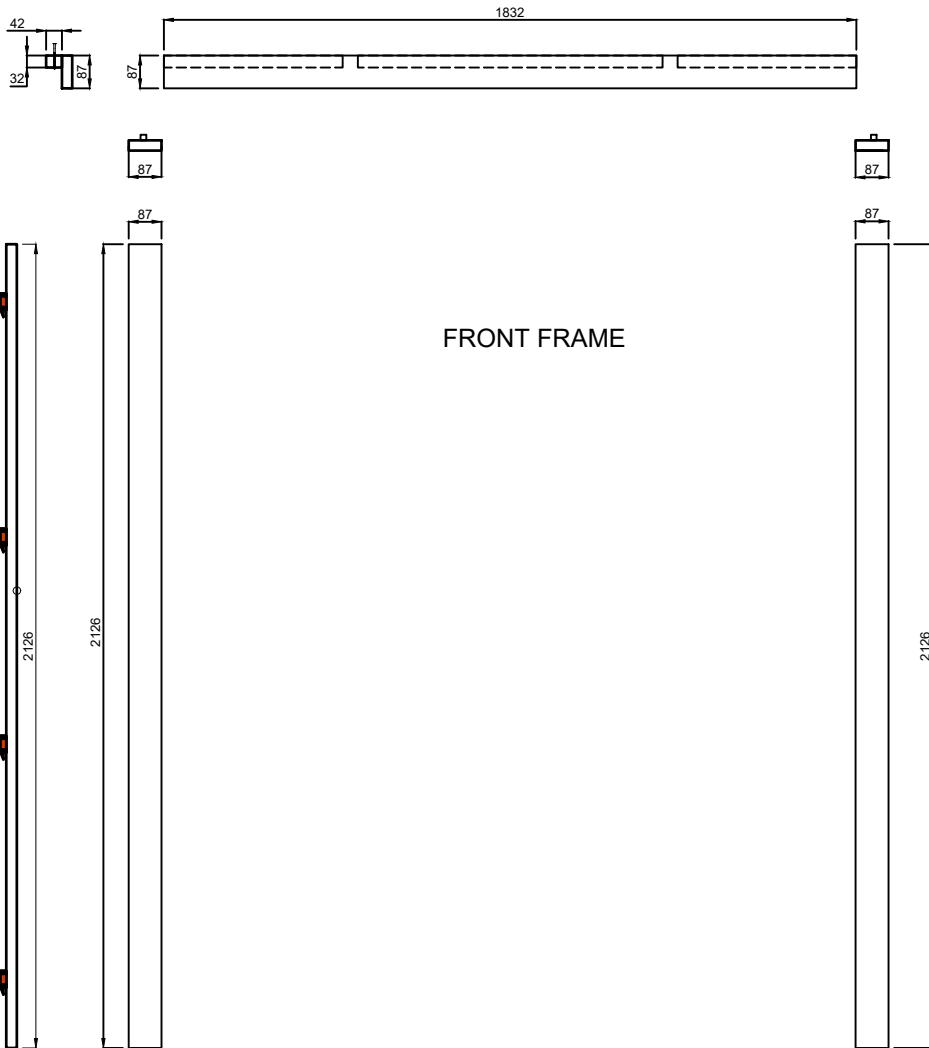

# Instructions for use and maintenance of pre-built and pre-assembled indoor and outdoor saunas

## 1. General installation requirements

- 1.1. Your sauna should be installed by a professional installer.
- 1.2. The installer of the sauna must have familiarised themselves thoroughly with the manufacturer's warranty terms and the installation instructions of the purchased sauna.
- 1.3. The electrical components of the sauna may be installed and connected only by a person with the respective certified competence.
- 1.4. The wooden parts of the sauna must not be in permanent contact with water or the structures of the room.
- 1.5. The exterior surfaces of the sauna must not be directly exposed to excessive humidity.
- 1.6. The installation site must have proper grid connection readiness for supplying power to the electrical components of the sauna. Requirements applicable at the installation location (country).

## 2. On-site requirements - indoor sauna

- 2.1. Make sure adequate ventilation is ensured in the room to be used for installing the sauna to ventilate the humidity and warm air created by the sauna.
- 2.2. Fresh air supply for the sauna room and heater must also be ensured. Be sure to leave an air gap between the sauna structures and the boundary structures of the room. This is necessary to avoid formation of excessive condensation between the structures of both the building and the sauna that could damage them and shorten their lifetime. The manufacturer recommends ensuring a minimum distance of 50 mm.
- 2.3. The installation surface must be level and stable.

## 3. On-site requirements - outdoor sauna

- 3.1. The outdoor sauna is designed to be installed on a pre-prepared level and stable surface capable of bearing the load.
- 3.2. Safety distances - you must leave at least a two-metre clearance around the sauna, unless specified otherwise or provided otherwise by the local requirements for similar buildings.
- 3.3. If your sauna is delivered pre-assembled, the installation site must be accessible for heavy machinery.

## 4. Sauna heater and heating stones

- 4.1. Install the sauna heater according to the heater manufacturer's installation instructions.
- 4.2. Install the heating stones according to the heater manufacturer's instructions. Installation requirements for the heating stones may vary depending on the sauna heater selected. As a general rule, the heating elements of the heater must be covered with stones. Pouring water directly on the heating elements will shorten the life of the heater and pose a health risk (hot water splashes).
- 4.3. It is recommended to wash the heating stones with water before installation. This cleans the stones of any possible processing and production residues.
- 4.4. Using the heater without the stones is not allowed.



## Instructions for use and maintenance of pre-built and pre-assembled indoor and outdoor saunas

5. Finishing/treating the wooden parts of the sauna with a protective agent
  - 5.1. Before using the sauna, all wooden surfaces must be treated with a suitable protective agent. The manufacturer recommends using sauna wax or sauna oil (paraffin oil).
  - 5.2. Depending on the installation method used for your sauna and the free space left in and around the sauna, the wooden surfaces can be treated before or after installing the parts but certainly before using the sauna.
  - 5.3. Treating the wood will extend the lifetime of the wood and your sauna, preserving its properties and appearance. Treated surfaces repel water and dirt and are easier to clean.
6. Taking the sauna into use
  - 6.1. Make sure all parts of your sauna are intact and functional after installation and before the first heating.
  - 6.2. First heating: slowly heat your sauna to a temperature of 100 °C under supervision, keep this temperature for two hours and let the sauna cool down slowly. The sauna must be well ventilated during the first heating - it is recommended to leave the door half-open. This is necessary to allow the wood protecting agent to be absorbed into the wood and any residues from production and processing to evaporate from the surfaces.
  - 6.3. Staying in the sauna during the first heating is not allowed - substances evaporating from surfaces may cause an unpleasant smell.
7. Using your sauna
  - 7.1. Use the sauna only for the purpose for which it was manufactured.
  - 7.2. Pour water only on the heating stones.
  - 7.3. Use the sauna in moderation - it stimulates circulation, relaxes muscles and cleanses.
  - 7.4. Rinse yourself with water between sauna sessions.
  - 7.5. It is recommended to drink mineral water after the sauna to replenish fluids.
8. General sauna maintenance
  - 8.1. After each use:
    - Wipe the bench with a damp cloth after.
    - Always remove pools of water from wooden surfaces.
    - If the design of the bench allows it, raise the platforms to an upright position to dry.
    - Let the heater run under supervision for approximately 20 minutes - wooden parts dry more efficiently this way.

## Instructions for use and maintenance of pre-built and pre-assembled indoor and outdoor saunas

### 8.2. Once a year or as needed:

- Wash the horizontal (and, if necessary, vertical) surfaces of your sauna with a special sauna detergent. Use a soft brush or damp cloth and observe the instructions of the detergent.
- Stronger stains can be removed with fine-grained sandpaper. All treated surfaces must be treated with a protective agent.
- Repeat treatment of the wooden parts with a protective agent.
- Check the structures of the sauna (bench fastenings, wall connections) and, if necessary, tighten the fastenings.
- Have a competent person check the condition of the electrical connections and components.
- Check the functioning of the door and adjust it, if necessary and possible.
- Check the condition of the heating stones: when used intensively and especially as they age, they could emit stone dust that will accumulate on the wooden surface above and behind the heater. Replace the stones, if necessary.
- Do not use substances or working procedures not suited for washing the sauna.
- Washing wooden parts with running water is not allowed.

### 9. Maintenance of an outdoor sauna

9.1. Trees and bushes growing near the sauna and a shady location may cause mossing on the surfaces. Clean the surfaces with a soft brush and damp cloth, as necessary.

9.2. In areas with thick snow-cover, remove snow from the roof of the sauna. Do not allow more than 50 cm of snow on the roof.

### 10. Wooden materials in the sauna

10.1. Wood is a natural material and subject to natural phenomena (differences in grain pattern, variations in tone, expansion and contraction due to heat and moisture).

10.2. Wood may develop cracks or deformations over time. This is natural and does not affect the use of the sauna. If in doubt, contact the vendor.

10.3. Thermally modified wood emits some scent during the first three heating periods.

### 11. Repair works

11.1. Damage to wood - scratches and dents up to 1 mm deep:

- Clean and dry the surface thoroughly.
- Sand down with 500 grit sandpaper or until dispersed.
- Clean off dust and treat with a protective agent. The protective agent will even out the colour difference caused by sanding.

### 12. The following are not allowed in the sauna:

12.1. Drying clothes or other textiles. Evaporating humidity may damage the wood; and textiles placed near the sauna heater may pose a fire hazard.

12.2. Heating to a temperature higher than 115 °C - fire hazard.

12.3. Placing combustible materials on the sauna heater.

12.4.

# Warranty terms for saunas and sauna products

Effective from 1.04.2022

## 1. definitions

1.1 **"Manufacturer"** is Auroom OÜ (registration code 14867010).

1.2 **"Product"** means a sauna or sauna product (including a sauna bath, sauna door or sauna accessory) manufactured by the Manufacturer for indoor or outdoor use, whether prefabricated or assembled.

1.3 **"Seller"** means an authorised reseller of the Manufacturer.

1.4 **"Customer"** is the person who has purchased the Product from the Seller for its intended use.

1.5 **"Defect"** means a failure or defect in the Product (including a manufacturing or material defect) that prevents the Product from being used as intended.

## 2. content and scope of the warranty

2.1 **"Warranty"** means the obligation of the Manufacturer to remedy Defects notified to it by the Customer or the Seller during the Warranty Period and caused by the acts or omissions of the Manufacturer, or to reimburse the Customer or the Seller for the costs incurred by the Customer or the Seller, with the prior agreement of the Manufacturer, in remedying such Defects. The method of remedying the Defect shall be at the discretion of the Manufacturer.

2.2 The warranty does not apply to third parties to whom the Customer has transferred the Product. A Customer who is not a consumer is not covered by the Warranty unless the Manufacturer has previously confirmed this to the individual Customer in a form that can be reproduced in writing. A Consumer Customer who has purchased the Product directly from the Manufacturer shall be subject to the warranty terms contained in the sales contract instead of the Warranty.

2.3 **The "Warranty Period"** is 2 years from the date of delivery of the Product to the Customer who is a consumer, but not more than 3 years from the date of manufacture of the Product. Unless the Customer or the Seller proves to the Manufacturer the date of delivery of the Product to the Customer, the Warranty Period shall be 2 years from the date of the conclusion of the sales contract for the Product with the Customer. If neither the Customer nor the Seller proves to the Manufacturer the date of conclusion of the sales contract for the Product with the Customer, the Warranty Period shall be 2 years from the date of manufacture of the Product. If the Manufacturer replaces a Product with a Defective Product, the Warranty Period shall be 2 years from the date of delivery of the replaced Product to the Customer. If the defective Product is repaired by the Manufacturer, the Warranty Period shall be 2 years from the date of repair in respect of the repaired Defect.

2.4 The Warranty does not cover:

(a) Defects that are not caused by the acts or omissions of the Manufacturer, including where (i) the Product has not been installed in accordance with its installation instructions; (ii) the Product has not been used in accordance with its instructions for use and maintenance; (iii) the Product has been stored in an unsuitable manner (including being exposed to the elements, high temperature fluctuations, or excessive humidity, being stacked, etc.); (iv) the Product has been damaged during installation or use; (v) the Defect has been caused by the use with the Product of equipment or components other than those supplied by the Manufacturer, or by a failure of such equipment or components; or (vi) the Defect has been caused by force majeure, unforeseeable events or extraordinary weather conditions (e.g. vandalism, fire, flood);

(b) natural wear and tear that occurs during the intended use of the Product;

(c) naturally occurring and expected characteristics of wood materials (differences in wood grain, knots, slight variations in tone) and phenomena that occur naturally during use of the Product (shrinkage and expansion due to temperature and humidity, moderate deformation) and the visual disturbances they may cause; nor

(d) Defects (including transport damage) that would have been detectable by visual inspection prior to installation of the Product.

# Warranty terms for saunas and sauna products

Effective from 1.04.2022

2.5 The Warranty does not apply if:

- (a) the Customer has not notified the Seller or the Manufacturer within 2 months of becoming aware of the Defect;
- (b) the Seller has failed to notify the Manufacturer within 2 weeks of the time at which it became aware or should have become aware of the Defect;
- (c) the Customer or the Seller has knowingly provided false information about the alleged Defect;
- (d) the Seller has not paid in full the invoice submitted to it by the Manufacturer for the defective Product;
- (e) the Customer has continued to use the Product after the discovery of the Defect without the prior consent of the Manufacturer in a form that can be reproduced in writing; or
- (f) the Product has been in public use or in similar conditions of heavy use without the prior written consent of the Manufacturer.

2.6 Equipment installed in or accompanying the Product and supplied by the Manufacturer is covered by the warranties provided by the manufacturers of such equipment and brokered by the Manufacturer.

## 1. submission and handling of a warranty claim

3.1 Upon discovery of a defect, the Customer must immediately cease using the Product and submit a warranty claim to the Seller. If it is not possible to submit a warranty claim to the Seller or if the Seller does not respond, the Customer may submit a warranty claim directly to the Manufacturer.

3.2 The warranty claim must contain at least the following information: the name of the Customer; the address where the Product is located; the name and contact details of the person making the warranty claim; the Product's product code or name and, if available, serial number; the date of delivery of the Product to the Customer or, if unknown, the date of sale of the Product to the Customer; a description of the Defect; and the Customer's preferred remedy.

3.3 The warranty claim must be accompanied by: a copy of the document certifying the date of delivery or sale of the Product; photographs in general plan and close-up showing the Defect in good quality.

3.4 The manufacturer will reply to the warranty claim as soon as possible, but no later than two weeks from the receipt thereof. If the Manufacturer is unable to establish on the basis of the information contained in the warranty claim that the Defect is covered by the Warranty, the Manufacturer may require the person making the warranty claim or the Seller to provide further evidence and explanations. In the case of a Defect covered by the Warranty, the Manufacturer shall inform the person making the claim of the manner and time for remedying the Defect.

## 2. final provisions

4.1 The granting of the warranty is without prejudice to the Customer's statutory rights, including the right to exercise against the Seller all remedies available to it under the law.

4.2 Without limiting the Manufacturer's liability under the law for defective Product, the Manufacturer shall not be liable for any consequential damages that the Customer, the Seller or any third party may incur in connection with the use of or inability to use the Product.

4.3 The Seller may provide additional warranties to the Customer in its name and for its account. The Manufacturer shall not be liable to the Customer for the performance of such warranties.

**Nail/screw set for  
200x200 Sauna Emma Glass**

<u>Screws:</u>	<u>Amount:</u>	<u>Comment:</u>		
<b>5x80 mm:</b>	<b>80 pcs.</b>	Walls	30 <b>pcs.</b>	Glasswall 8 <b>pcs.</b>
		Ceiling elements	12 <b>pcs.</b>	
		Bench frames	20 <b>pcs.</b>	
<b>5x70 mm:</b>	<b>15 pcs.</b>	Bench supports	10 <b>pcs.</b>	
<b>4x45 mm:</b>	<b>60 pcs.</b>	Backrest	9 <b>pcs.</b>	Glasswall 8 <b>pcs.</b>
		Upper frame	6 <b>pcs.</b>	Bench grid 8 <b>pcs.</b>
		Ceiling plywood	16 <b>pcs.</b>	
<b>4x30 mm:</b>	<b>6 pcs.</b>	Base frame	4 <b>pcs.</b>	
<b>Nails 1,5x45 mm:</b>	<b>20 pcs.</b>	Mouldings	10 <b>pcs.</b>	

**NOTE:** *There are some extra items (screws, nails) also for the sauna!*